



Hot Runner Manual

For robust molding of semi-crystalline resins

Introduction

Maximizing productivity is an important factor in determining part cost. One way to improve productivity is using a hot runner system. The decision when to use a hot runner system is mainly influenced by “yield” as hot runners can add complexity and cost to molds and require additional maintenance. Due to continuous improvement in the hot runner design a robust molding process is possible even with traditionally more thermally sensitive thermoplastic resins.

The hot runner design requirements for semi-crystalline polymers, such as DuPont™ Delrin® (POM), DuPont™ Zytel® (PA), DuPont™ Minlon® (PA), DuPont™ Zytel® HTN (PPA), DuPont™ Rynite® (PET), DuPont™ Crastin® (PBT), DuPont™ Sorona® (PTT), and some DuPont™ Hytrel® (TPC-ET) differs from amorphous polymers in the way of their softening, melting and freezing behaviors. Amorphous materials (like softer Hytrel® grades) gradually soften with slowly decreasing viscosity from the solid state (T_g) to the processing temperature. This behavior provides a wide temperature range to control viscosity when melting or freezing the resin.

On the other hand, a semi-crystalline polymer becomes fluid with a relatively low viscosity at a defined melting temperature (T_m). In the same way, a semi-crystalline resin freezes again at a defined freezing temperature, where no flow is possible. As a result, the processing window for the melting and freezing of semi-crystalline resins is relatively narrow, which needs to be considered when designing a hot runner system. This manual gives guidance on basic gate design and hot runner selection for the robust molding of semi-crystalline resins.

Contents

Introduction	1
1 Gate designs	2
1.1 Indirect hot runner gating using cold sub runner	2
1.2 Direct hot runner gating of the part	2
2 Hot runner selection	2
2.1 Nozzle design	2
2.1.1 Hot Runners with Open Nozzle or Torpedo	3
2.1.2 Hot Runners with Valve Gates (Shut-off Nozzles)	4
3 Hot Runner Manifold	4
4 Temperature distribution inside the Hot Runner	4
5 Temperature control of the cavity	5
6 Temperature settings for Dupont Semi-crystalline Resins	6
7 Safety considerations	6

1 Gate designs

When using a hot runner system in a mold there are basically two different gating scenarios possible:

- Indirect hot runner gating of the part using cold sub runners
- Direct hot runner gating of the part

The advantages and disadvantages of the different gatedesigns, as well as the preferred solution depending on resinchoice and part design, are described in the following chapter.

1.1 Indirect Hot Runner gating using a Cold Sub Runner

Whenever possible it is recommended to use a hot runner combined with a cold sub runner when molding semicrystalline resins. This combination requires less precise thermal control around the nozzle tip and therefore contributes to a more robust process. With indirect gating, it is recommended to move the nozzle tip back from the parting line to avoid heat loss at the nozzle tip area once the tool is closed. Especially with parts

requiring a long hold pressure time and a good packing, indirect gating is highly recommended as the freezing time of a cold runner is better to control versus a hot tip. For the cold sub-runner, a cold slug trap in front of the hot tip should be provided to catch any frozen or degraded material, preventing it from entering the cavity.

Cold runner and gate designs should follow the guidelines for semi-crystalline resins. It is recommended that the gate diameter (d) should be at least half of the wall thickness (T) of the part. The diameter (D) of the tunnel next to the gate should be at least 1.2 times the part thickness. The amorphous gate design shown on the right side in Figure 1 is not recommended for semi-crystalline resins due to the risk of an early freezing and therefore an insufficient hold pressure time. This can result in uncontrolled shrinkage that causes voids and/or sink marks, low mechanical performance, and dimensional problems.

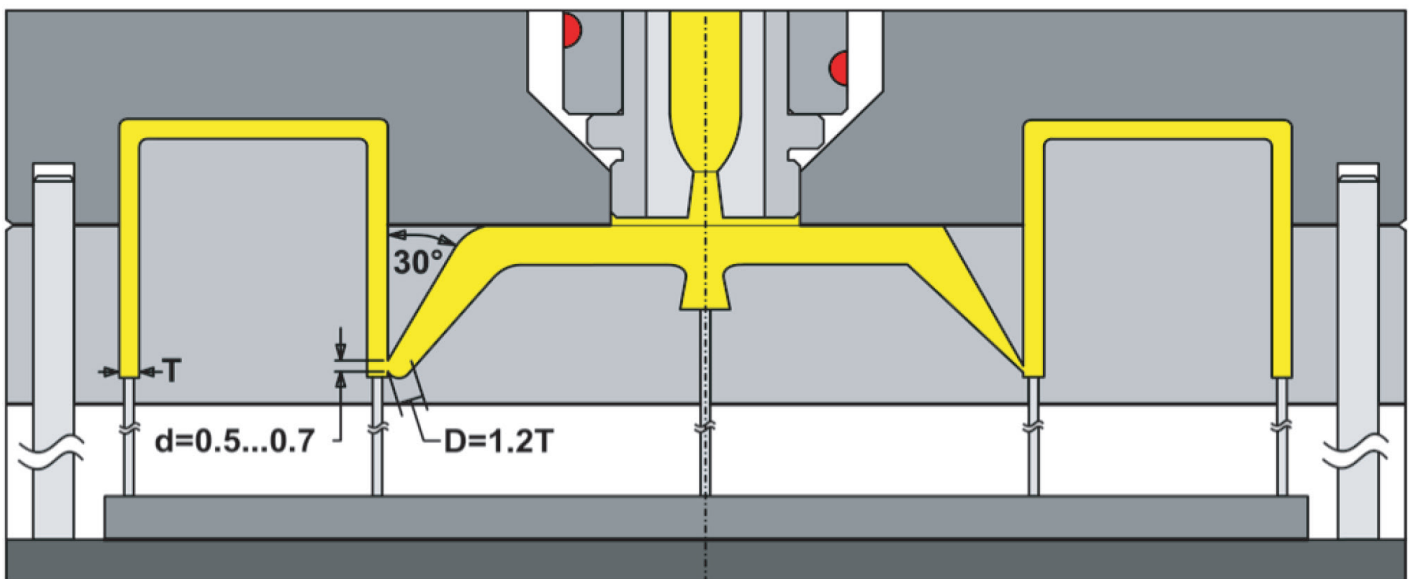

Figure 1: Indirect hot runner gating using a cold sub runner. Tunnel gate for semi-crystalline resins (left), tunnel gate for amorphous resins (right).

1.2 Direct Hot Runner gating of the part

If it is requested to direct gate the part there are either non-self-insulating nozzle tip designs (see Figure 4) or self-insulating nozzle tip designs (see Figure 3) available. Whenever it is possible, a hot runner nozzle with a non-selfinsulating nozzle tip should be used. A non-self-insulating nozzle tip has less

risk of material stagnation with improved maintenance in the case of abrasion and corrosion. If the part is gated on a surface which does not allow an exchangeable nozzle tip, a self-insulating nozzle could be used. However, with a self-insulating nozzle there is a higher risk of hold-up spots and therefore material degradation, as described in the next chapter.

2 Hot Runner selection

2.1 Nozzle Design

There are two basic types of designs for hot runner nozzles that are widely used in injection molding:

- Open nozzle (includes also open nozzle with torpedo and internally heated nozzles)
- Valve gate nozzle (shut-off nozzle)

When molding semi-crystalline resins, the nozzle design should allow a precise freezing and therefore a controlled separation between molten material in the nozzle tip and frozen material in the cavity. Poor nozzle design often leads to

freezing of the nozzle or to stringing and drooling and thus to production and quality issues. To avoid freezing of the nozzle tip during mold opening or production stop, attention needs to be given to the thermal insulation between the hot nozzle tip and the mold. Insufficient thermal insulation between the nozzle tip and mold generally leads to unacceptably high temperature settings of the hot runner and therefore to unacceptable material degradation.

Design recommendations to meet the requirements, depending on resin choice and part design, are described in the following chapters.

2.1.1 Hot Runners with Open Nozzle or Torpedo

An open nozzle design, as shown in Figure 2, offers good flow properties and is often used when molding highly filled and abrasive materials. This design is not recommended for unreinforced materials as the freezing behavior of those materials limits precise separation of the bushing/runner and the molten material at the nozzle tip. Thus, stringing in the gate area occurs during mold opening. For an open nozzle design, as shown in Figure 2, it is recommended to always gate the part by indirect gating, using a cold sub runner equipped with a cold slug trap (see Chapter 1.1). For highly filled resins, it is recommended to use an exchangeable nozzle tip for the ease of maintenance.

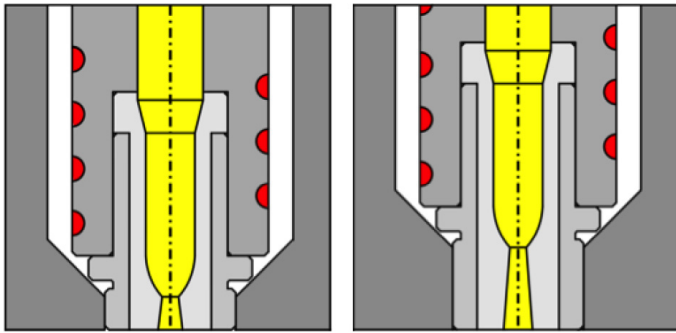

Figure 2: Open nozzle design with short bushing (left) and long bushing (right)

Unlike the open nozzle, a system equipped with a torpedo is suitable for direct gating of the part. In general, for unreinforced resins, an open nozzle design with torpedo avoids problems with stringing and is recommended instead of using an open nozzle design without torpedo. However, for direct gating of parts with high surface aspect requirements, there is a risk of uncontrollable flow marks around the gate depending on the torpedo design. Nozzles with a torpedo are less suitable for processing highly filled or flame-retardant resins due to their flow restriction. Internally heated nozzles, as shown in Figure 3, are not recommended for molding semi-crystalline resins because of the risk of stagnation on hot steel surfaces. It is a common practice to add a separate cooling circuit around the nozzle to be more independent from the mold temperature in controlling the temperature around the nozzle and the nozzle tip.

Unlike the open nozzle, a system equipped with a torpedo is suitable for direct gating of the part. In general, for unreinforced resins, an open nozzle design with torpedo avoids problems with stringing and is recommended instead of using an open nozzle design without torpedo. However, for direct gating of parts with high surface aspect requirements, there is a risk of uncontrollable flow marks around the gate depending on the torpedo design. Nozzles with a torpedo are less suitable for processing highly filled or flame-retardant resins due to their flow restriction. Internally heated nozzles, as shown in Figure 3, are not recommended for molding semi-crystalline resins because of the risk of stagnation on hot steel surfaces. It is a common practice to add a separate cooling circuit around the nozzle to be more independent from the mold temperature in controlling the temperature around the nozzle and the nozzle tip.

Unlike the open nozzle, a system equipped with a torpedo is suitable for direct gating of the part. In general, for unreinforced resins, an open nozzle design with torpedo avoids problems with stringing and is recommended instead of using an open nozzle design without torpedo. However, for direct gating of parts with high surface aspect requirements, there is a risk of uncontrollable flow marks around the gate depending on the torpedo design. Nozzles with a torpedo are less suitable for processing highly filled or flame-retardant resins due to their flow restriction. Internally heated nozzles, as shown in Figure 3, are not recommended for molding semi-crystalline resins because of the risk of stagnation on hot steel surfaces. It is a common practice to add a separate cooling circuit around the nozzle to be more independent from the mold temperature in controlling the temperature around the nozzle and the nozzle tip.

Whenever the nozzle tip is self-insulated by the molded resin, as shown in Figure 3, there is a high risk of stagnation and therefore purging of degraded resin into the part. This leads to material degradation, causing surface defects around the gating and black specks in the finished parts. To avoid the stagnation and hold-up spots, customers have good experience using Titanium or DuPont™ Vespel® caps at the nozzle tip.

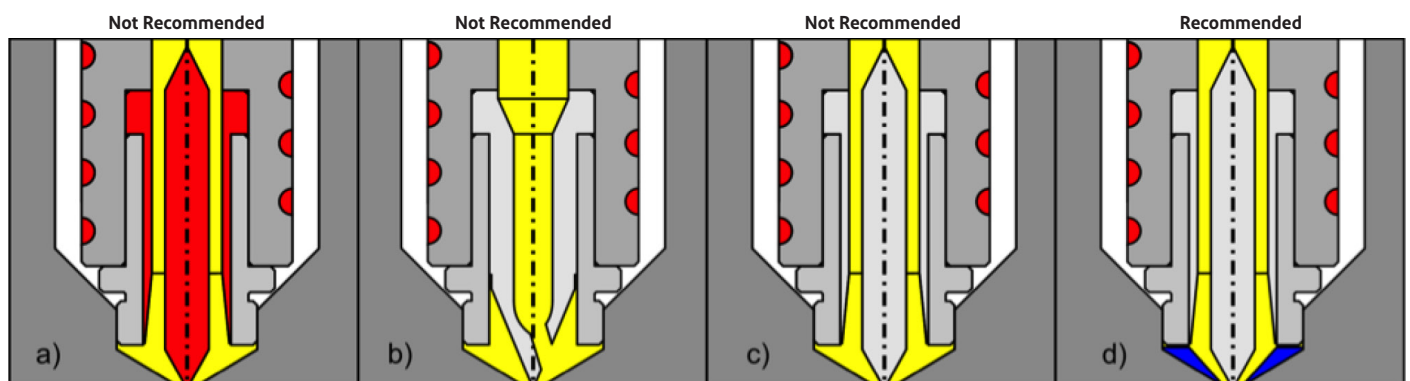

Figure 3: Torpedo nozzle design, internally heated torpedo (a), torpedo with flow restriction (b), torpedo (c), torpedo with Titanium/Vespel® cap (d)

2.1.2 Hot Runners with Valve Gates (Shut-off Nozzles)

Hot runner systems with valve gates are more frequently used for the molding of precision parts made from semi-crystalline resins. Especially for multi-cavity tools with more than one nozzle it is strongly recommended to use a valve gate system to ensure balanced filling of all cavities. Furthermore, when molding bigger parts where the pressure drop for filling is too high, a valve gated hot runner system with a selected number of nozzles allows a segmented filling and stable packing by opening the valves in cascade. Depending on the nozzle design and the thermal insulation between nozzle and tool, a valve gated hot runner nozzle may lead to a limited hold pressure time. This is due to an early freezing at the valve pin guide before achieving the sealing time of the part. In this case in the gating area often a cold deformation occurs once the needle is closing or a remaining pin is visible on the molded part. If this happens the thermal insulation of the hot runner nozzle needs to be improved to avoid part breakage in the gating area as well as dimensional instability and an increased number of voids of the molded parts.

Cylindrical guidance of the valve pin is always recommended when molding semi-crystalline resins. With a conical shape,

there is a high risk of deforming the sealing surface especially with reinforced resins. For thermally sensitive resins, which are critical to hold up time, an adapted manifold design with an improved purging behavior is preferred (see Figure 4).

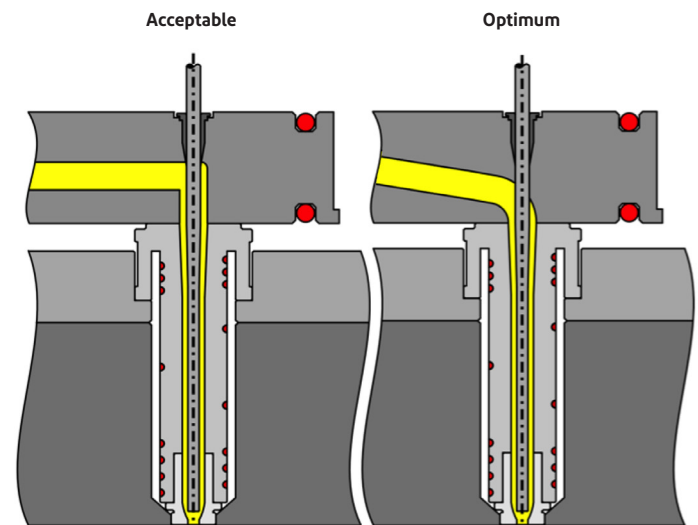

Figure 4: Valve gate design, standard manifold design (left), improved design minimizes stagnation (right)

3 Hot Runner Manifold

If there is more than one nozzle used in the tool, the melt is transported to the hot runner nozzles by the manifold system. In general, the channels of the manifold should be as smooth as possible to minimize melt sticking to the tool steel. To avoid corrosion inside the hot runner a steel with a higher chrome content is preferred.

To achieve uniform filling of all cavities, it is recommended to use naturally balanced systems. All channel corners should be flow optimized to avoid hold-up spots and minimize pressure drop in the manifold. Sharp corners in manifolds result in high shear stress, potential degradation of the material and increased abrasion for reinforced resins. Hot runner suppliers offer a wide range of flow optimized geometries.

Figure 5 shows channel corner designs which are available from hot runner suppliers.

The design shown in Figure 5 (a) is not suitable for molding semi-crystalline resins. In addition, the purging behavior is very limited when changing the color or the material. An optimum flow design which minimizes shear, pressure drop and the risk of hold-up spots is shown in Figure 5 (c). This solution is the most expensive but offers the best flow properties and purging behavior. In Figure 5 (b) a compromise between design and cost of the hot runner is shown. However, this is not recommended for molding optical parts and resins which are highly reinforced and/or less thermally stable.

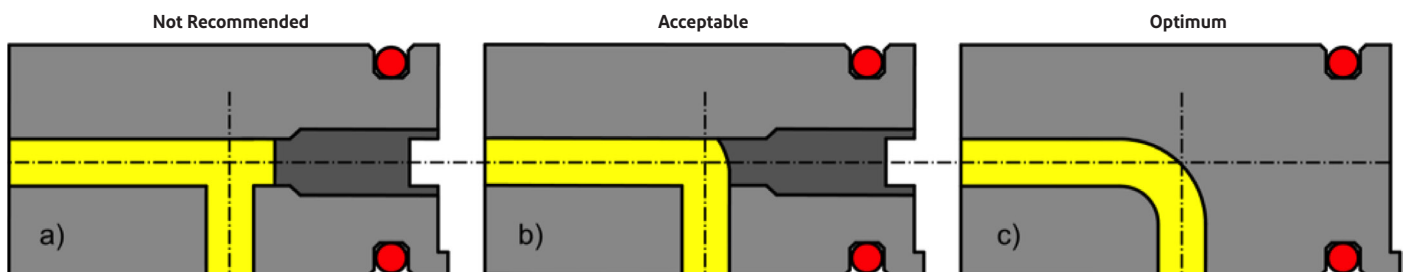

Figure 5: Manifold channel corner design

4 Temperature Distribution inside the Hot Runner

To achieve a stable and robust molding condition it is important that the temperature distribution inside the nozzle and the manifold is as uniform as possible. Therefore, when assembling a hot runner system into a mold the gap between nozzle, manifold and the tool needs to be well defined. A too narrow gap leads to a heat loss of the hot runner system to

the tool by heat radiation. However, a too big gap leads to a chimney effect and therefore also to an unacceptable heat loss of the hot runner system. At the supporting pins there is always a higher heat transfer to the tool. To minimize the heat transfer it is recommended to use a material with low thermal conductivity.

To achieve a temperature distribution as uniform as possible at the manifold, it is strongly recommended that the manifold is heated from both sides, as shown in Figure 5. When assembling a hot runner nozzle into the tool the contact area between tool and hot runner should be minimized to avoid a freezing of the nozzle due to an unacceptable heat transfer from the nozzle tip to the mold, as shown in Figure 6. To assess the performance, it is recommended to stop the process for five minutes. If a startup after five minutes is possible using

recommended melt temperature settings of the hot runner nozzle the thermal insulation is sufficient.

If the nozzle is well assembled but it is difficult to control its temperature setting, the location of the thermocouple should be checked. It is recommended that the location of the thermocouple is close to the nozzle tip, as shown in Figure 6. Also, it is important that the thermocouple is well connected to the steel of the nozzle.

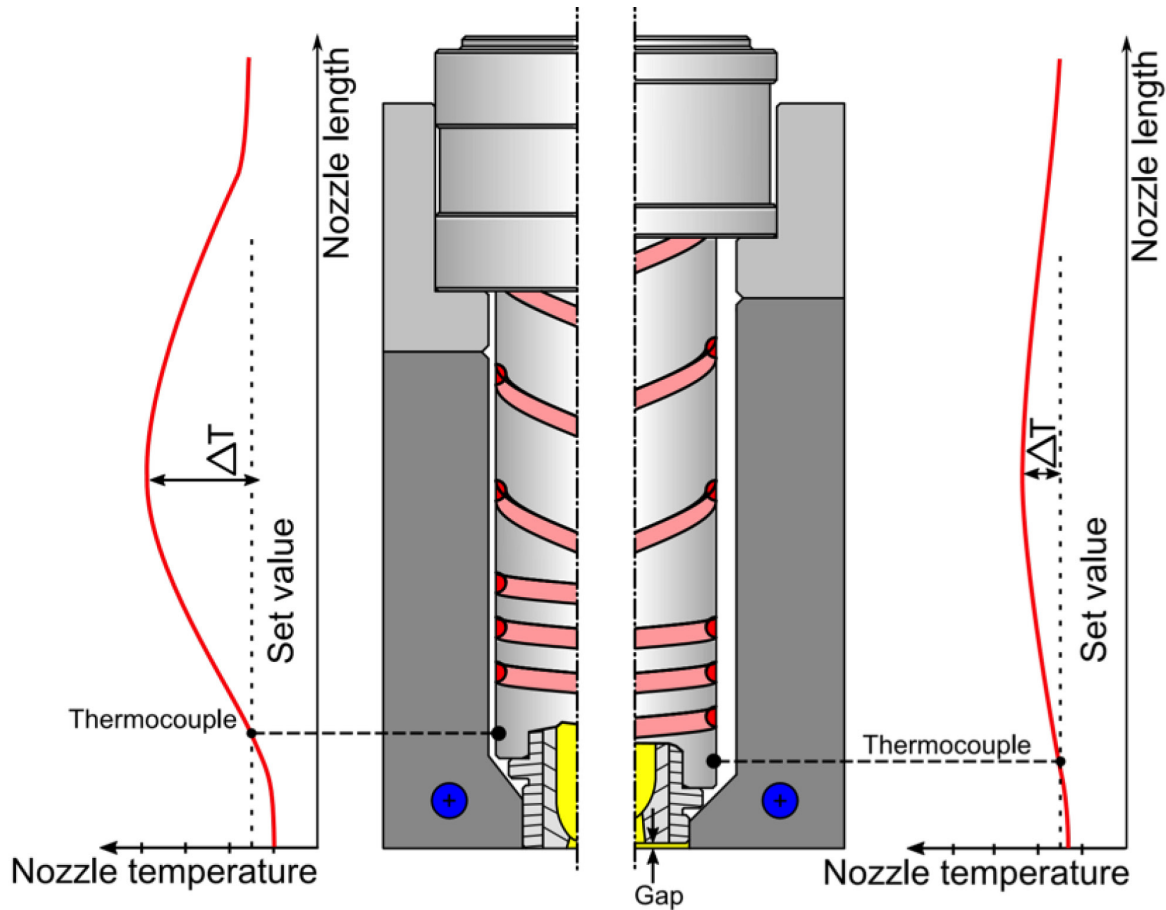

Figure 6: Nozzle temperature gradient, large contact area = wide temperature difference (left), good thermal isolation = flat temperature profile (right)

5 Temperature Control of the Cavity

Cavity wall temperature uniformity can be a challenge close to the hot runner nozzle. To control the temperature around the nozzle, it is recommended to add separate cooling circuits around the nozzle as shown in Figure 7. For parts with high mechanical and optical requirements, it is always recommended to use a cold sub runner to avoid defects close to the gate due to nonuniform cavity surface temperatures.

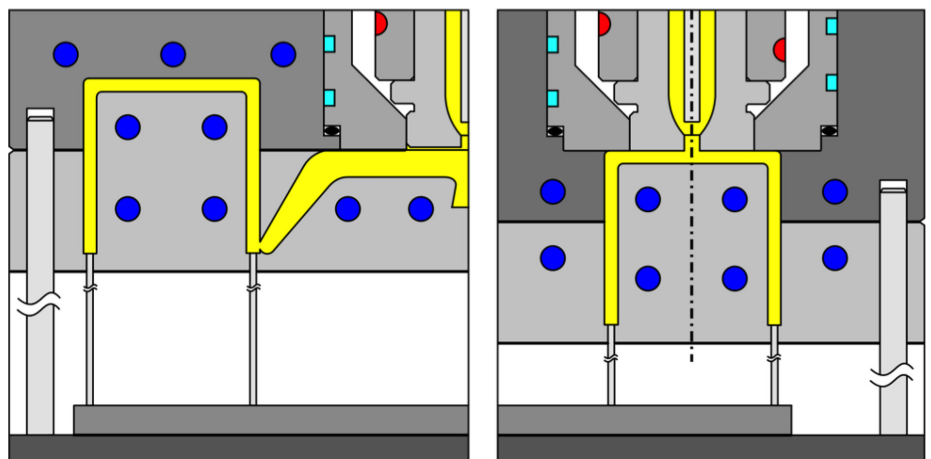

Figure 7: Separated temperature control to achieve uniform mold surface temperature, indirect gating with cold sub-runner (left), hot runner direct gating (right)

6 Temperature Settings for Dupont Semi-Crystalline Resins

It is worth noting that a hot runner system does not contribute to the homogeneity of the melt. The task of a hot runner itself is to transfer the melt to the cavity without significant heat-loss. Therefore, it is not recommended to run a hot runner at a higher temperature than recommended to improve melt quality and/or reduce viscosity.

Running a hot runner system above the recommended temperature may cause degradation of the resin. As a result, problems with surface defects and black specks as well as mold deposit increase dramatically. Table 1 shows an overview of the recommended temperature settings for DuPont resins.

Table 1: Recommended temperature settings

Material	Material type	Melting point [°C]	Recommended temperature setting screw/barrel [°C]	Recommended temperature setting hot runner [°C]
Delrin®	POM	178	215	190
Zytel® and Minlon®	PA66	260	290 – 295	As screw/ barrel setting
	PA6	220	260 – 280	
Zytel® HTN	PPA	295 – 310	310 – 325	
Crastin®	PBT	223	250 – 260	
Rynite®	PET	250	285	
Hytrel®	TPC-ET	152 – 221*	180 – 250*	

*: Melting point and recommended barrel temperature depend on Shore D hardness of the Hytrel® resin.

For most of the DuPont semi-crystalline resins, the temperature in the hot runner system can be set according to the temperature recommendation for the barrel. The hot runner temperature setting of Delrin® acetal resin differs from other DuPont semi-crystalline resins as the optimum barrel temperature is in many cases higher than the optimum hot runner temperature. Delrin® is sensitive to excessive heat and can degrade if exposed for too long at high temperatures. The lower temperature minimizes the heat exposure of the resin

and is generally high enough to avoid freezing of the Delrin® resin in the hot runner channel.

Temperature settings shown in Table 1 are intended as an initial guideline. As hot runner systems can vary from case to case, adjustments may be necessary. The manifold temperature should be set according to Table 1. However, the temperature of the hot runner nozzle should not exceed those temperatures by more than 5 to 10 °C.

7 Safety Considerations

While processing thermoplastic resins, all potential hazards must be anticipated and either eliminated or guarded against by following established industry procedures. Hazards may include:

- Thermal burns resulting from exposure to hot molten polymer
- Fumes generated during drying, processing, and regrind operations
- Formation of gaseous and liquid degradation products

Safety data sheets include such information as hazardous components, health hazards, emergency and first aid procedures, disposal procedures, and storage information. Refer to the specific product Molding Guide for more information on safe handling.

Note: Adequate ventilation and proper protective equipment should be used during all aspects of the molding process. Refer to the DuPont Ventilation Guide for more detailed information.

NO WARRANTY - PLEASE READ CAREFULLY

The information set forth herein is furnished free of charge, is based on technical data that DuPont believes to be reliable, and represents typical values that fall within the normal range of properties. This information relates only to the specific material designated and may not be valid for such material used in combination with other materials or in other processes. It is intended for use by persons having technical skill, at their own discretion and risk. This information should not be used to establish specification limits nor used alone as the basis of design. Handling precaution information is given with the understanding that those using it will satisfy themselves that their particular conditions of use present no health or safety hazards and comply with applicable law. Since conditions of product use and disposal are outside our control, we make no warranties, express or implied, and assume no liability in connection with any use of this information. As with any product, evaluation under end-use conditions prior to specification is essential. Nothing herein is to be taken as a license to operate or a recommendation to infringe on patents.

CAUTION: Do not use DuPont materials in medical applications involving implantation in the human body or contact with internal body fluids or tissues unless the material has been provided from DuPont under a written contract that is consistent with the DuPont policy regarding medical applications and expressly acknowledges the contemplated use. For further information, please contact your DuPont representative.

DuPont™, the DuPont Oval Logo, and all trademarks and service marks denoted with ™, SM or ® are owned by affiliates of DuPont de Nemours, Inc. unless otherwise noted.

© 2019 DuPont. All rights reserved.
001-20208-PBU0819

